

Location No.	Part Name	Material	No. for 1 Unit
1	Casing	304 Stainless	1
4	Casing cover	304 Stainless	1
7	Impeller	304 Stainless	1
8	Impeller	304 Stainless	1
9	Diffuser	304 Stainless	1
11	Mechanical seal	Carbon/Ceramic	1
14	Fan	Polypropolene	1
15	Fan cover	Steel	1
23*	Capacitor*	*Single phase only	1
24	Priming plug	303 Stainless	2
26	O-Ring	Viton	1
27	O-Ring	Viton	1
32	Key	304 Stainless	2
34	Impeller nut	304 Stainless	1
52	Terminal box	Polypropolene	1
53	Terminal cover	Polypropolene	1
72	Casing ring	Viton	1
73	Casing ring	Viton	1
75	Washer	304 Stainless	2
77	O-ring	Viton	2
79	Spacer diffuser	304 Stainless	1
92	Lip seal	—	1
93	Lip seal	—	1
102	Suction cover	304 Stainless	1
103	Conveyor cover	304 Stainless	1
105	Sleeve	304 Stainless	1

***Note: Capacitor for Single Phase ONLY**

Exploded view

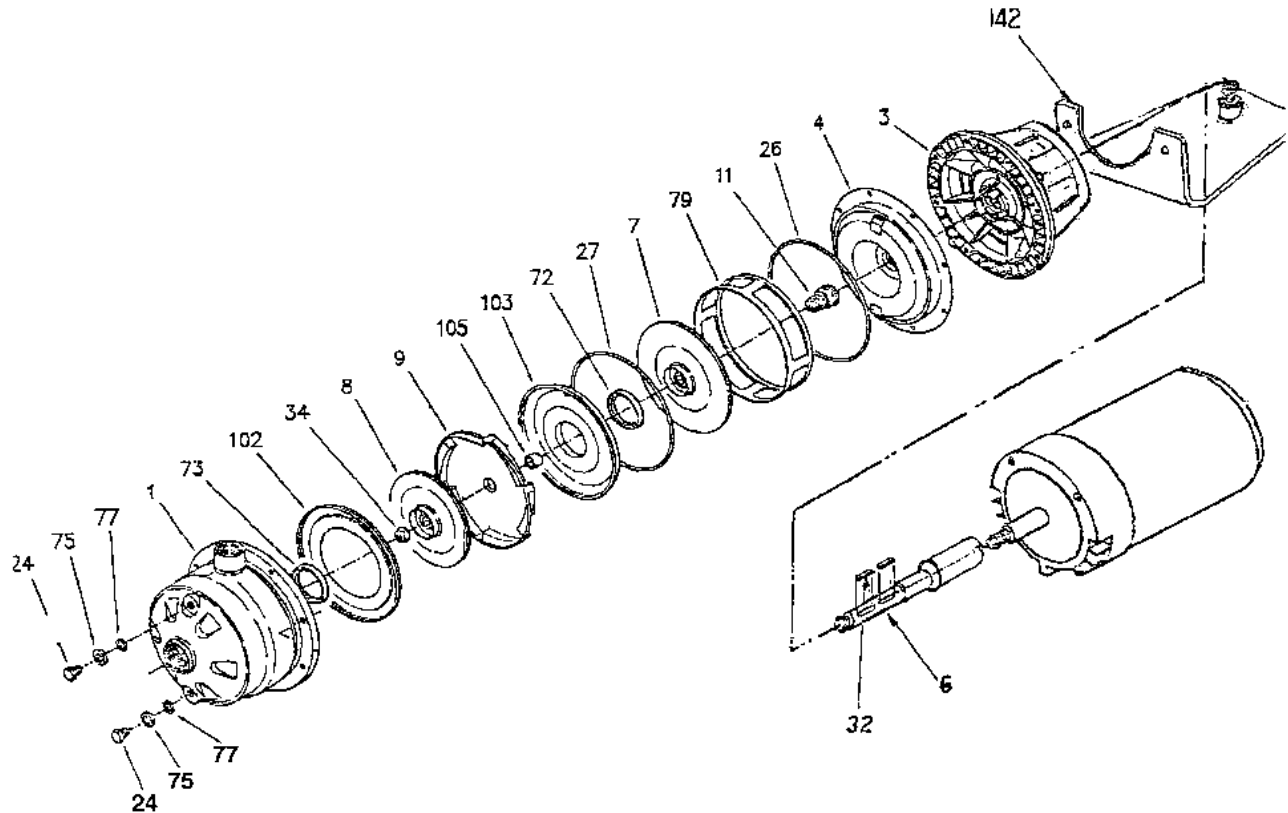

Location No.	Part Name	Material	No. for 1 Unit
001	Casing	304 Stainless	1
003	Motor bracket	Cast Aluminum	1
004	Casing cover	304 Stainless	1
006	Shaft extension	304 Stainless	1
007	Impeller	304 Stainless	1
008	Impeller	304 Stainless	1
009	Diffuser	304 Stainless	1
011	Mechanical Seal Type 21	Carbon/Ceramic	1
024	Priming plug/Drain plug	303 Stainless	2
026	O-Ring	Viton	1
027	O-Ring	Viton	1
032	Key	Stainless	2
034	Impeller nut	304 Stainless/Nylon	1
072	Casing ring	Viton	2
073	Casing ring	Viton	1
075	Washer	304 Stainless	2
077	O-ring	Viton	2
079	Spacer diffuser	304 Stainless	1
102	Suction cover	304 Stainless	1
103	Conveyor cover	304 Stainless	1
105	Sleeve	304 Stainless	1
142	Base	Steel	1

